

<回路図>

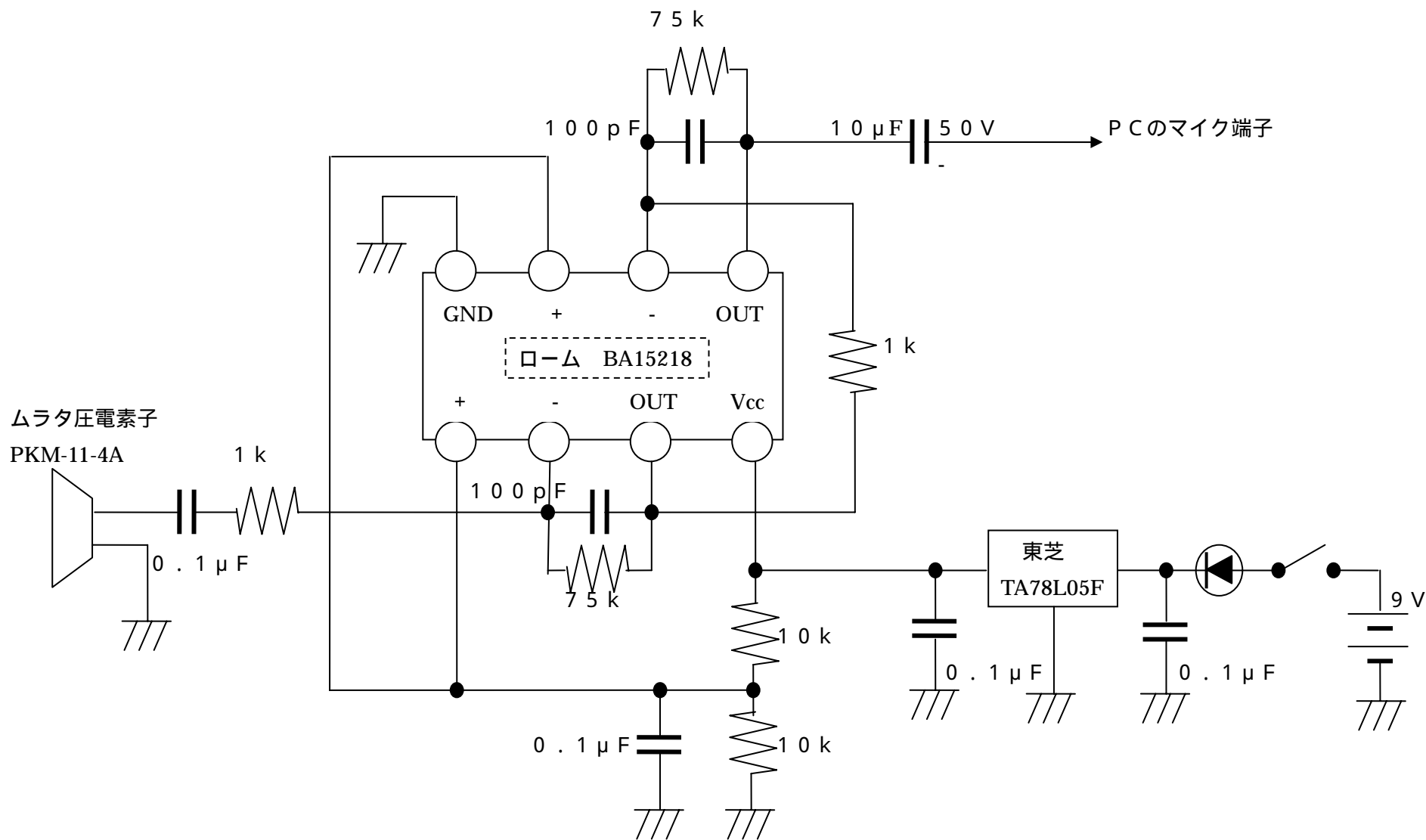

< 利得特性 >

2 mVpp の入力信号 (Ch : 2) の伝送特性を測定する。

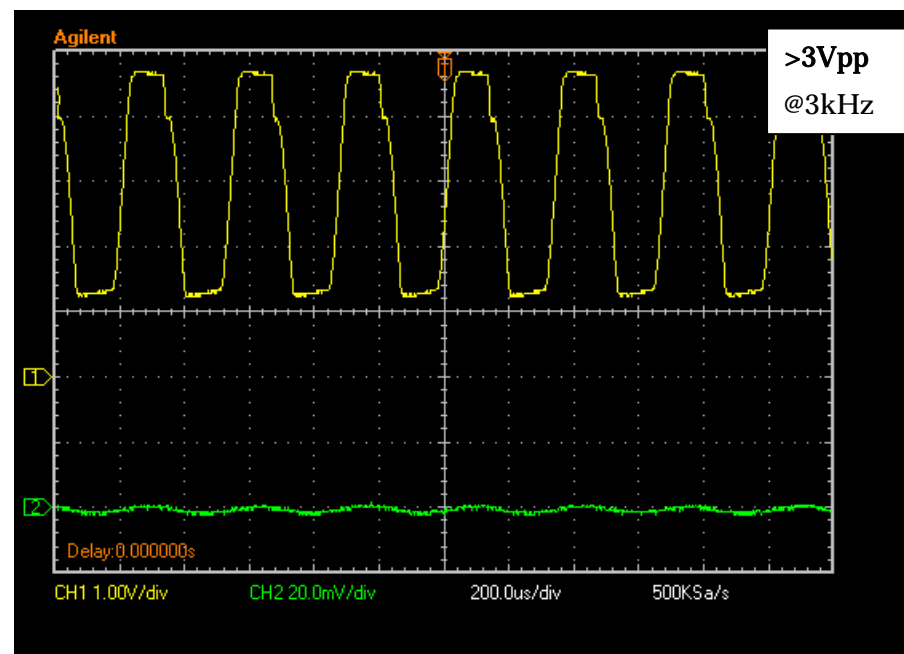
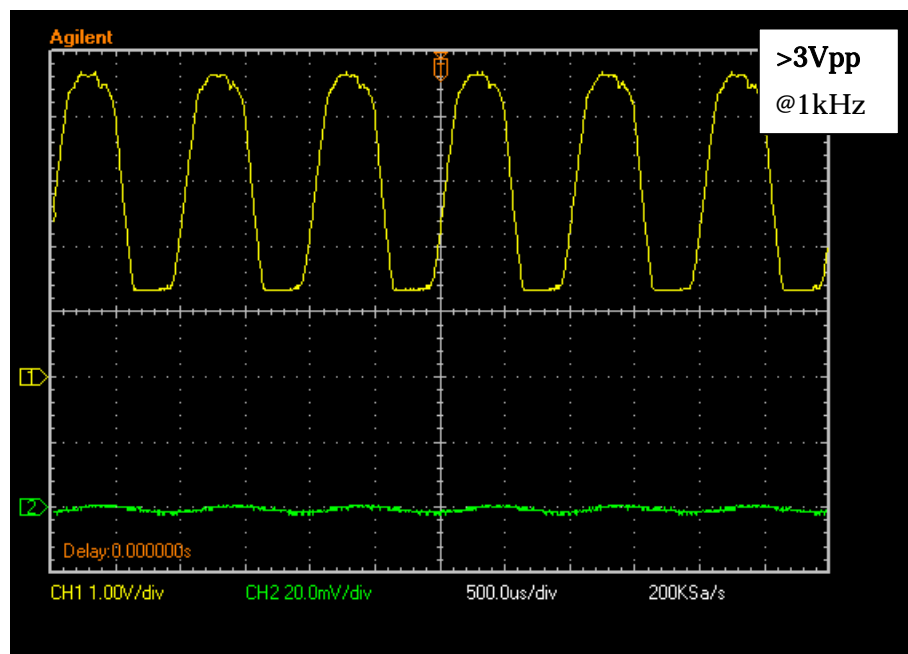
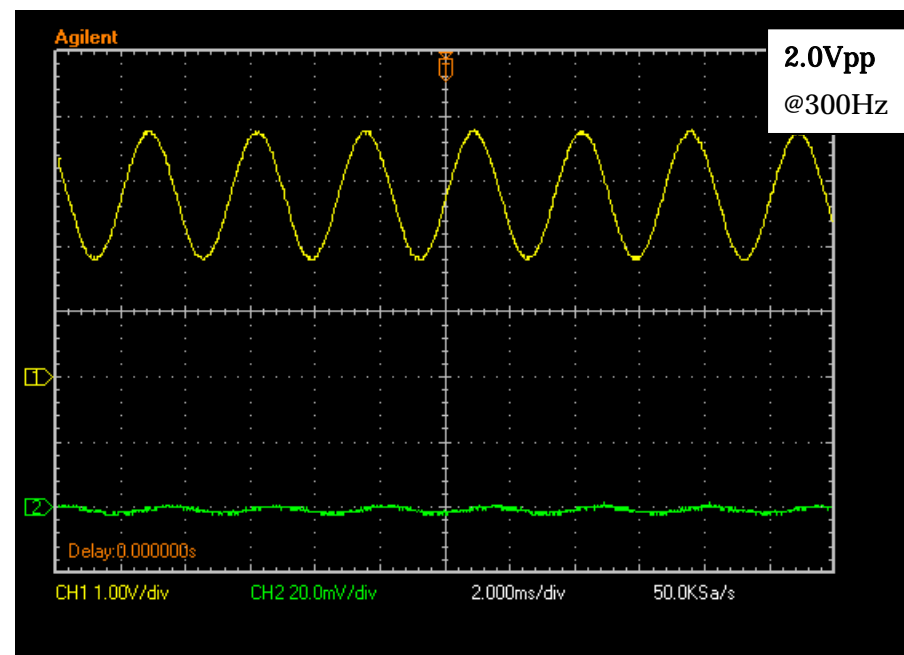
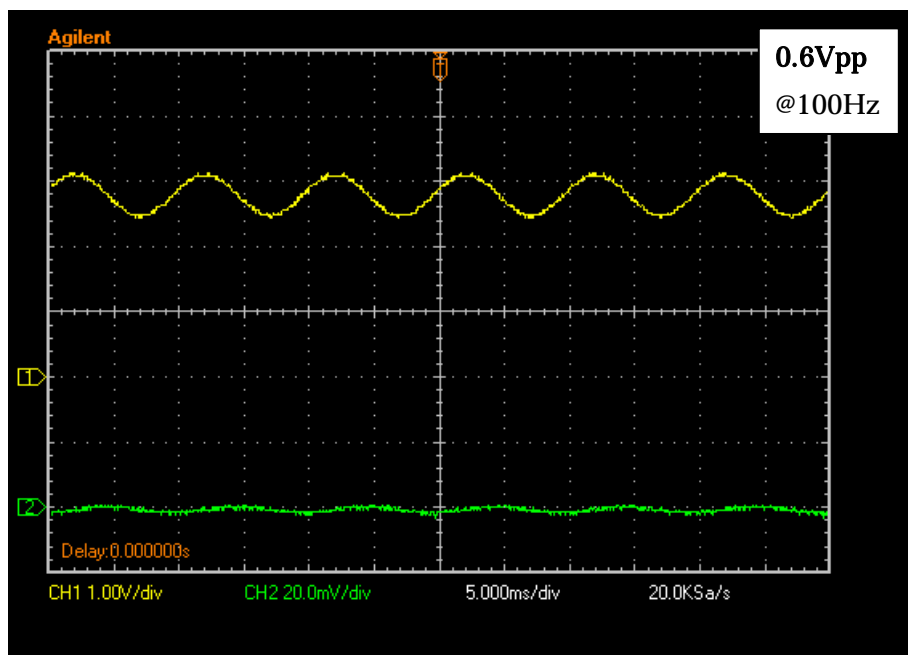

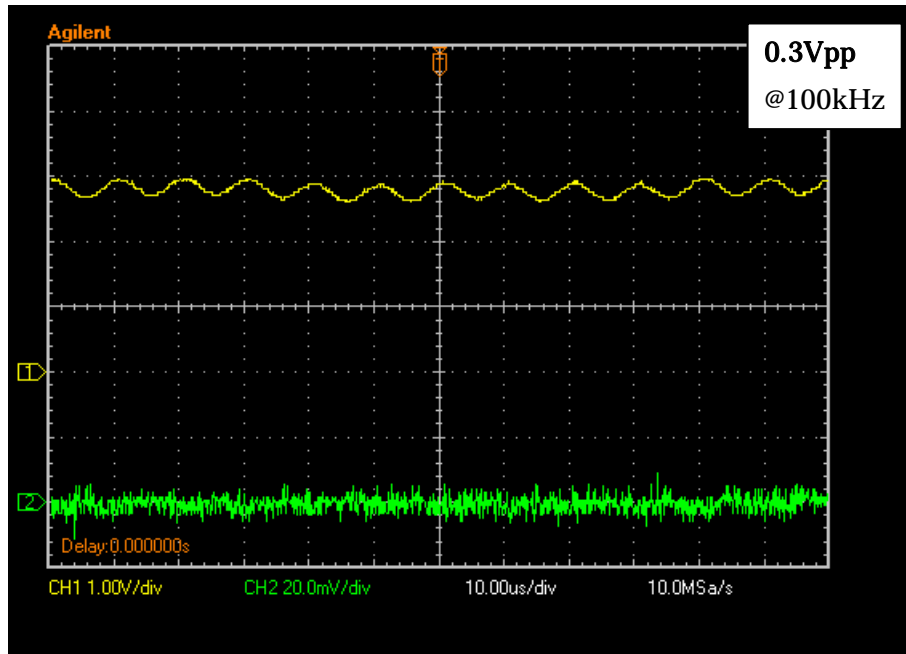
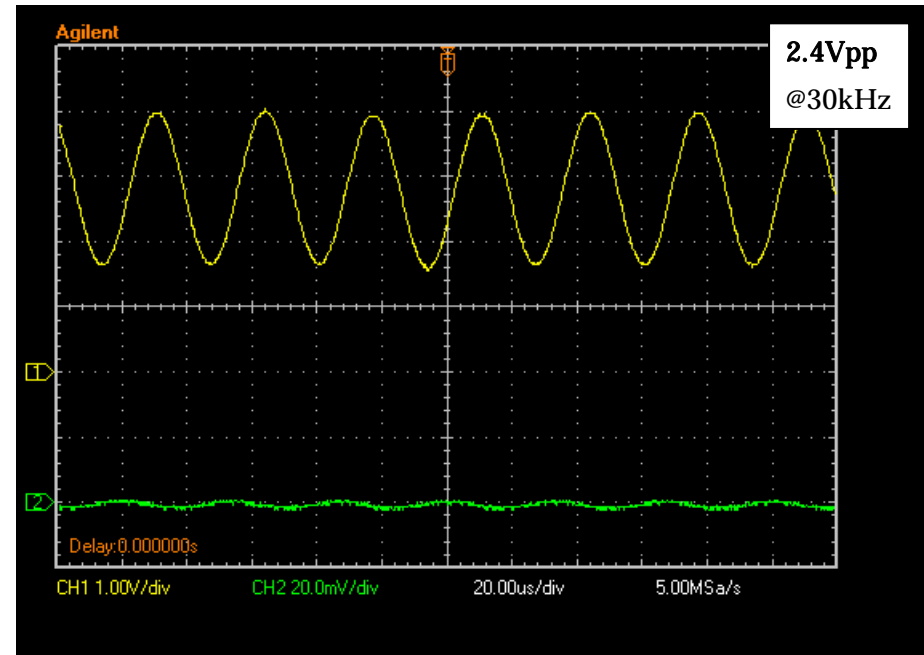
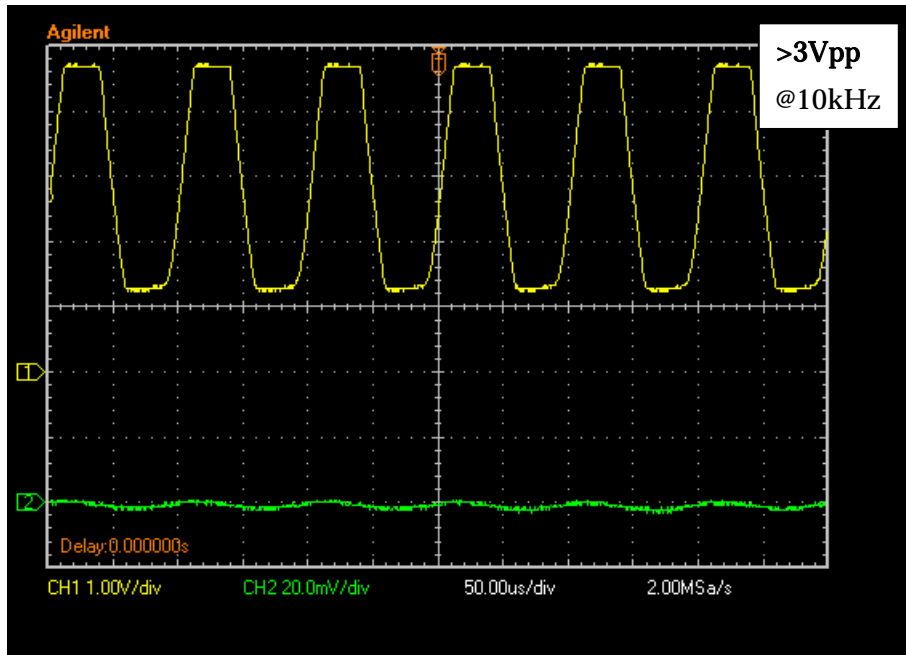

< 理論特性 >

